



Thule XT Kit 3040

> Instructions

CHRYSLER Town & Country, 5-dr MPV, 06-07

CHRYSLER Voyager/Grand Voyager, 5-dr MPV, 06-07

DODGE Caravan/Grand Caravan, 5-dr MPV, 06-07

HYUNDAI Terracan, 5-dr SUV, 01-07

JEEP Commander, 5-dr SUV, 06-10

LEXUS RX 300, 5-dr SUV, 98-03

PLYMOUTH Voyager/Grand Voyager, 5-dr MPV, 06-07

This kit is only for vehicles with T-profile.

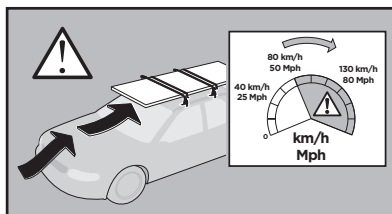
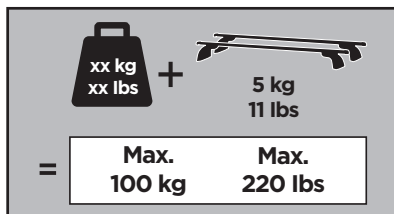
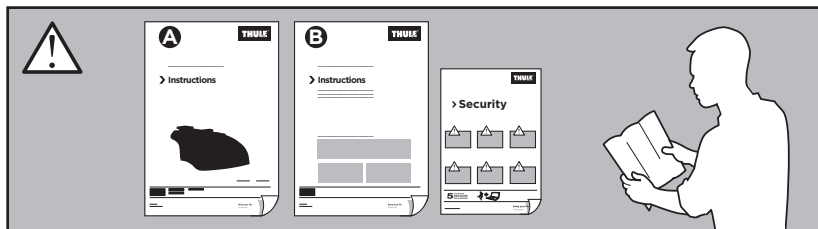

ISO 11154-E

183040

C.20160926
509-3040-04

Bring your life
thule.com

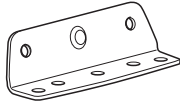

◀ 09 x4

50784



x4

50273

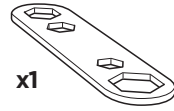

x1

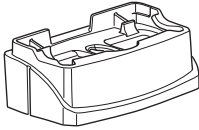

◀ 43 x4

30154



x4

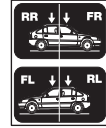

x1

51323

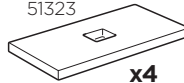

x4

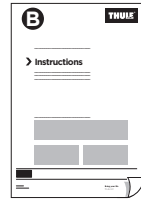

x1

A



x8

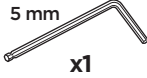

x1

50577

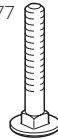

x4

1

09

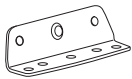

43

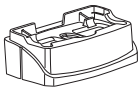

FL



FR



43

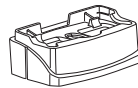

09

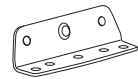

09

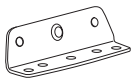

43



RL



RR



43



09

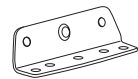

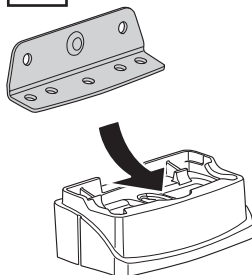
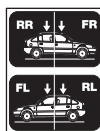
2 A**B A** 16 mm x8

x1

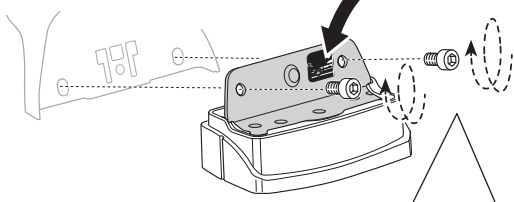
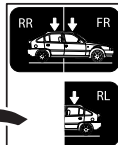
**EN** Only a few turns**DE** Nur wenige Umdrehungen**FR** Quelques tours uniquement**NL** Slechts enkele slagen**IT** Solo qualche giro**ES** Sólo algunas vueltas**PT** Noções básicas**SV** Endast några varv**DK** Kun nogle få omgange**NE** Bare noen få omdreinger**FI** Vain muutama kierros**ET** Ainult mõni pööre**LV** Tikai daži apgriezieni**LT** Tik keli pasukimai**PL** Wystarczy kilka obrotów**RU** Только несколько оборотов**UK** Лише декілька обертів**BG** Само няколко завъртания**CS** Pouze několik otáček**SK** Len niekoľko otáčok**SL** Le nekaj obratov**HR/BiH** Samo nekoliko okreta**RO** Doar câteva rotiri**HU** Csak néhány fordítás**EL** Μόνο λίγες περιστροφές**TR** Yalnızca birkaç tur

بعض دورات فقط

רק מספר סיבובים

ZH 仅几圈**JA** 2～3回転のみ**KO** 몇 번만 돌리면 됨**TH** เพียงสองสามรอบ**AR****HE****3**

x4

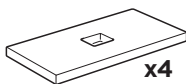

x4

CHRYSLER Town & Country
CHRYSLER Voyager/Grand Voyager
DODGE Caravan/Grand Caravan
PLYMOUTH Voyager/Grand Voyager

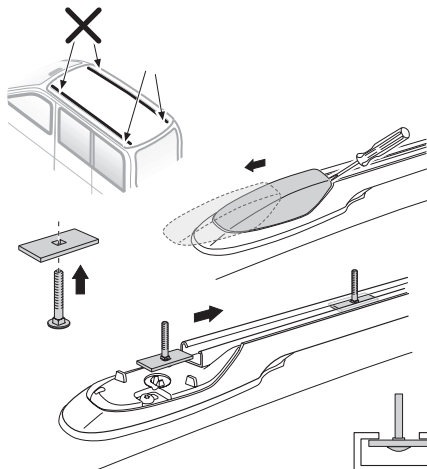

HYUNDAI Terracan
JEEP Commander
LEXUS RX 300

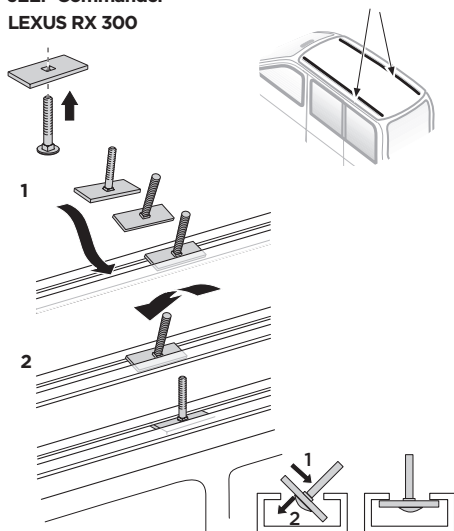

4



x4



x4

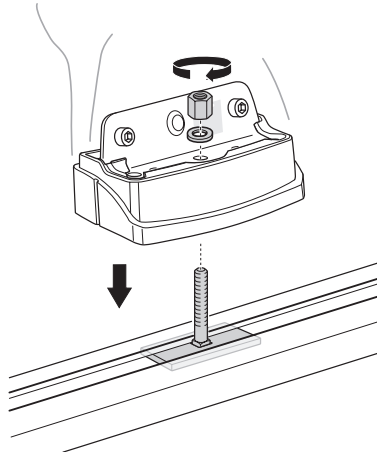

5



x1

A

5 mm



x1

A

4 Nm

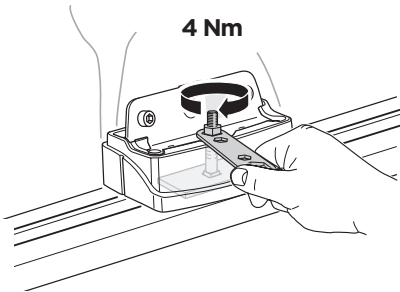

B

6 Nm

